

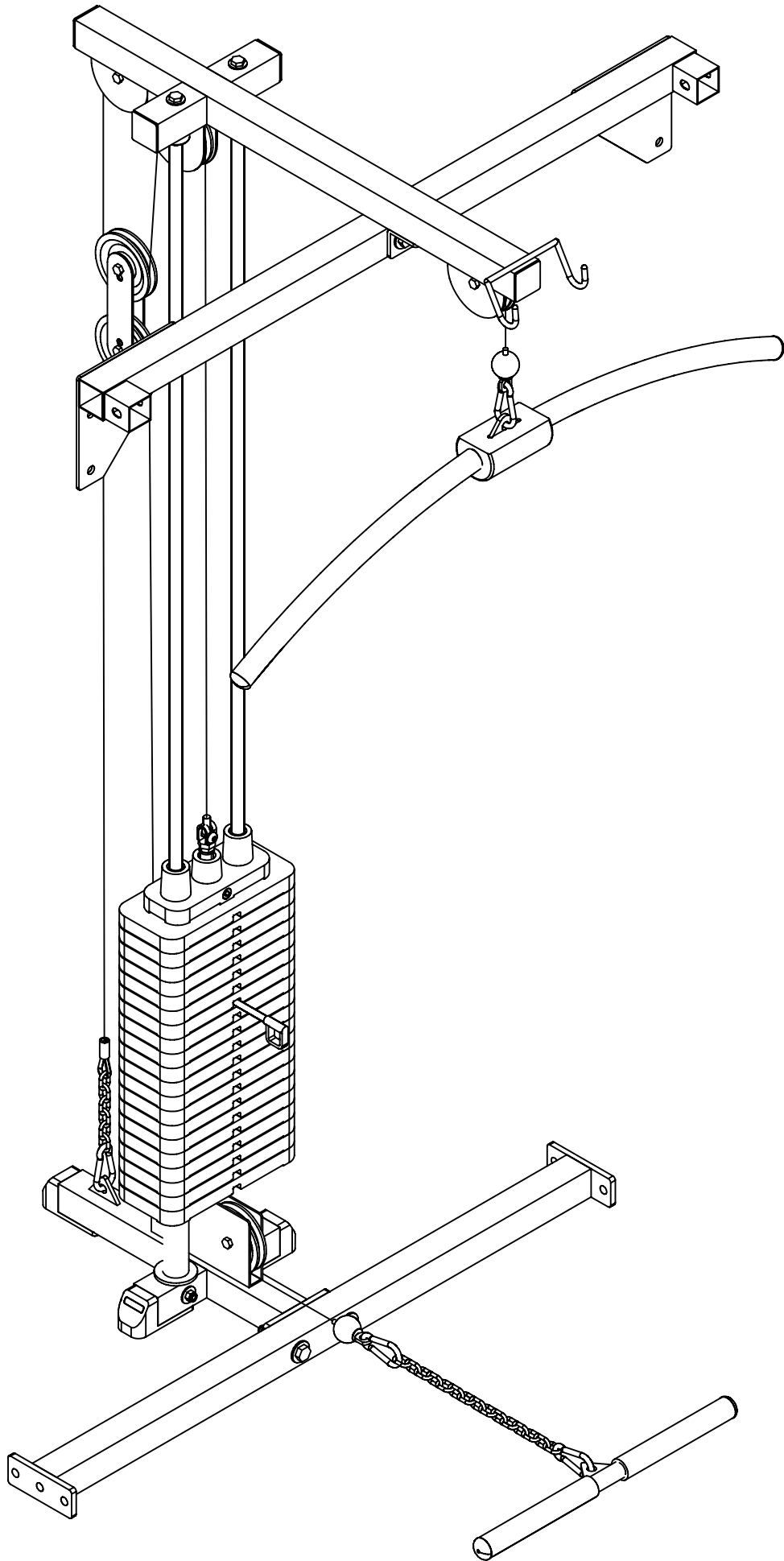







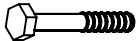
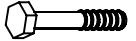

LA-80.3

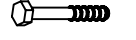
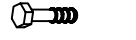

VERSION 0511

# LA-80.3

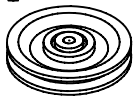
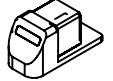
## HARDWARE ILLUSTRATION SHEET

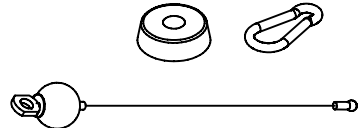
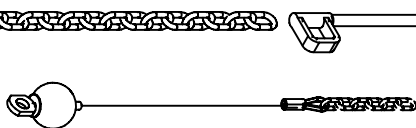
		Qty.
	A1. M12X80 HEX HEAD BOLT	[2PCS]
	A2. M12X75 HEX HEAD BOLT	[1PCS]
	A3. 7/16"X1 1/2" ROUND BOLT	[1PCS]
	A4. M10X65 HEX HEAD BOLT	[2PCS]
	A5. M10X40 HEX HEAD BOLT	[7PCS]
	A6. STEEL CHAIN	[1PCS]
	A7. PIN	[1PCS]
	A8. FIRM SHEATH (8890-010)	[1PCS]
	B1. M12 NYLON LOCK NUT	[3PCS]
	B2. M10 NYLON LOCK NUT	[9PCS]
	C1. M12 (I.D) WASHER	[4PCS]
	C2. M10 (I.D) WASHER	[4PCS]
D1 	D1. ø110 PULLEY (9213-002)	[7PCS]
	D2. 2"X2" FOOT CAP (9211-025)	[3PCS]
	D3. 2"X2" END CAP (9211-006)	[4PCS]
D2 	D4. ø1" ROUND END CAP(9260-021)	[4PCS]
	D5. ø2 1/2" RUBBER DONUT (9310-010)	[2PCS]
D3 	D6. ø8 SPRING SNAP LINK (8810-001)	[4PCS]
	D7. STEEL CABLE+ROUND	[1PCS]
	D8. STEEL CABLE+CHAIN	[1PCS]
D4 	D10. ø3/4" SHAFT COLLAR (9211-046)	[2PCS]
	D5 D6 D10 A6 A7	
D7 		
	D8 	

## PARTS ILLUSTRATION SHEET

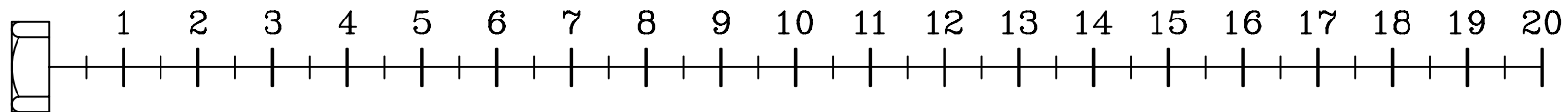
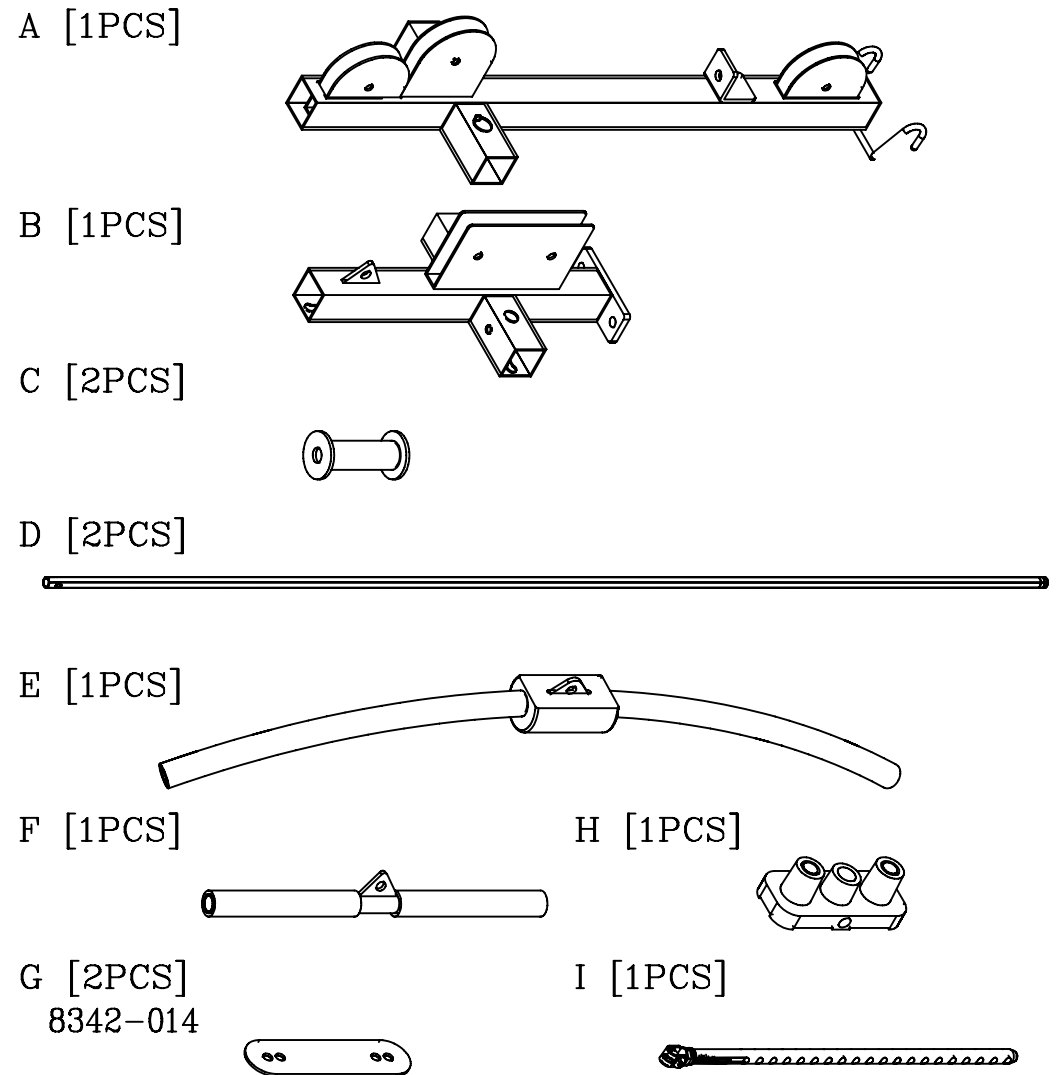

# LA-80.3

